



THE ULTIMATE FORCE

STAY COOL. BE TUF

# TUF-GTX1650S-O4G-GAMING

-Built TUF

## ASUS Exclusive Innovations

- **The GeForce GTX 1650 SUPER** is up to 50% faster than the original GTX 1650 and up to 2X faster than the previous-generation GTX 1050. Powered by the award-winning NVIDIA Turing™ architecture and ultra-fast GDDR6 memory, it's a supercharger for today's most popular games. Time to gear up and get SUPER.
- **Ultra-fast GDDR6** with over 50% more memory bandwidth for high-speed gaming.
- **GeForce Experience:** Capture and share videos, screenshots, and livestreams with friends. Keep your drivers up-to-date and optimize game settings. GeForce Experience lets you do it all, making it the essential companion to your GeForce graphics card.



## Space-Grade Lubricant

A new lubricant allows these sleeve bearings to deliver a quieter acoustic profile than dual ball bearing designs and match their durability.

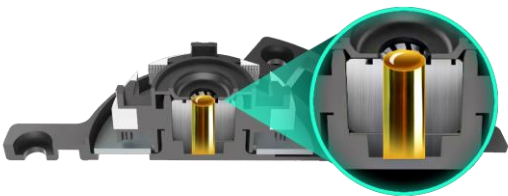

### Space-grade Lubricant

Ultra-low evaporation rate

## TUF Compatibility Testing

A suite of tests ensure flawless compatibility with TUF gaming motherboards, chassis, and other TUF alliance products.



\*The image is for reference only.



THE ULTIMATE FORCE

### ■ DirectCU II

Copper heatpipes make direct contact with the die for improved thermal transfer.

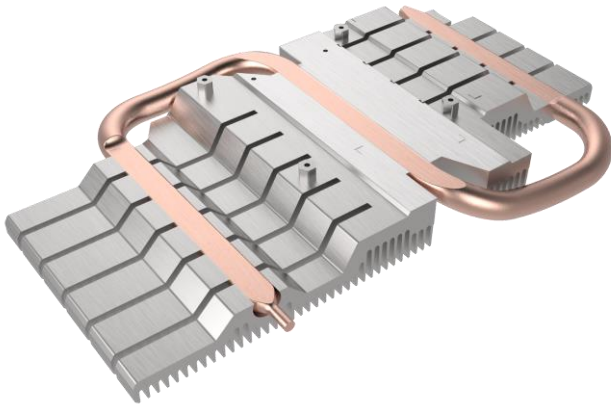

### ■ Protective Backplate

A rigid backplate prevents PCB flex and trace damage.



### ■ Auto-Extreme Technology

An automated manufacturing process that enhances reliability.

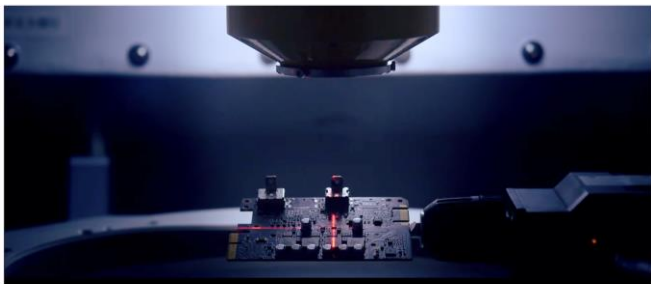

### ■ Software Suite

Tweak performance with GPU Tweak II, stream games with XSplit Gamecaster, get a better connection to game servers with wtfast, and earn passive income with Quantumcloud.



\*Free 14-day premium XSplit Gamecaster.

\*Six-month wtfast premium license\* — a USD\$53.95 value — to let user enjoy online gaming that's free from lag, latency and lost packets.



## ASUS Features

# OC Edition

- **OC Edition:** 1800 MHz GPU boost clock in OC mode for outstanding gaming experience.

# 4GB Memory

- **4GB GDDR6 Memory:** On-board memory for the best gaming experience & the best resolution.

## I/O Specifications

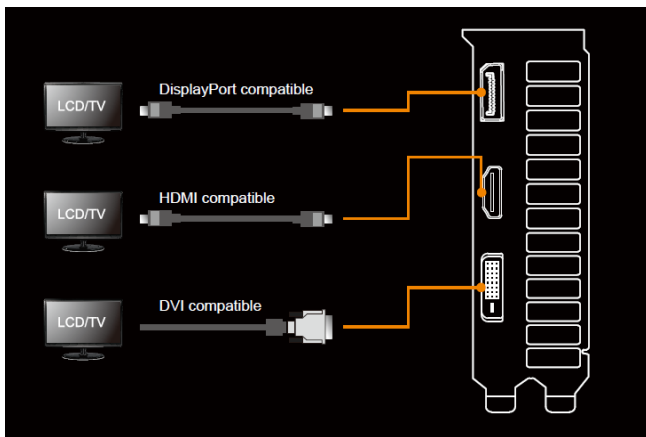

## Graphics GPU Features

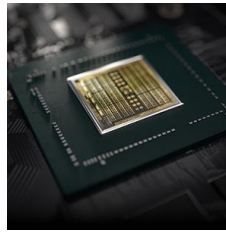

- **TURING SHADERS:** Featuring concurrent execution of floating point and integer operations, adaptive shading technology, and a new unified memory architecture with twice the cache of its predecessor, Turing shaders enable awesome performance increases in today's games. Get 1.4X power efficiency over the previous generation for a faster, cooler, and quieter gaming experience.

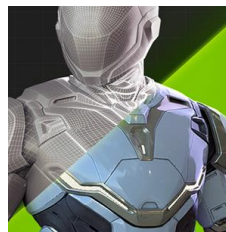

- **NVIDIA STUDIO:** Create without compromise. Studio combines NVIDIA GeForce GPUs with exclusive NVIDIA Studio Drivers designed to supercharge creative applications. Unlock dramatic performance and reliability—so you can create at the speed of imagination.



- **NVIDIA® ANSEL:** This powerful photo mode lets you take professional-grade screenshots of your games like never before. Now, you can share your most brilliant gaming experiences with super-resolution, 360-degree, HDR, and stereo capture modes.

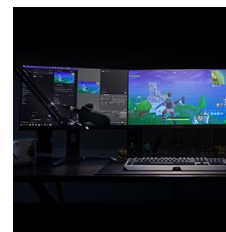

- **BROADCAST LIKE A PRO:** GeForce GTX® 16 SUPER™ Series features a dedicated hardware encoder that unlocks the ability to game and stream simultaneously with superior quality. SUPER graphics cards are optimized for your favorite streaming apps to provide maximum performance for your live stream.



- **FRAMES WIN GAMES:** Battle Royale games demand high FPS. Get the competitive edge you need with GeForce.



THE ULTIMATE FORCE

## Hardware Specification

Model	TUF-GTX1650S-O4G-GAMING
Graphics Engine	NVIDIA® GeForce® GTX 1650 SUPER™
CUDA cores	1280
OpenGL	OpenGL® 4.6
Engine Clock	OC mode : 1800 MHz (Boost Clock) Gaming mode : 1770 MHz (Boost Clock)/ 1530 MHz (Base Clock)
Memory Interface	128 bit
Video Memory	4GB GDDR6
Memory Clock	12002 MHz
Power connectors	1x 6-pin
I/O	1x Native HDMI 2.0b 1x Native DisplayPort 1.4a 1x Native DVI-D
HDCP compliant	HDCP 2.2
Digital Max Resolution	7680 x 4320
Maximum Display Support	3
SLI / Crossfire Support	N/A
Recommended PSU	350 W
Bus Standard	PCI-E 3.0
Package Contents	1x Speedsetup Manual
Software Bundled	ASUS GPU Tweak II & Driver, please download all software from the support site
Slot	2.3 slots
<b>Dimension</b>	
Card Size (cm/inch)	20.6 x 12.4 x 4.6 cm 8.1 x 4.9 x 1.8 inches
Color Box (mm)	364 x 217 x 66 mm
<b>Weight</b>	
Single Card (KG)	0.63
Product Weight (with packing) (KG)	1.08
Note	*All specifications are subject to change without notice. Please check with your supplier for exact offers. Products may not be available in all markets. If you do not use the latest and current specifications of ASUS products, you shall be liable for all loss and damage claimed by third party to ASUS based on false advertising or any other issues caused from using false specifications of ASUS products.





THE ULTIMATE FORCE

